

windirectTM
LED ASYMMETRIC LIGHTING

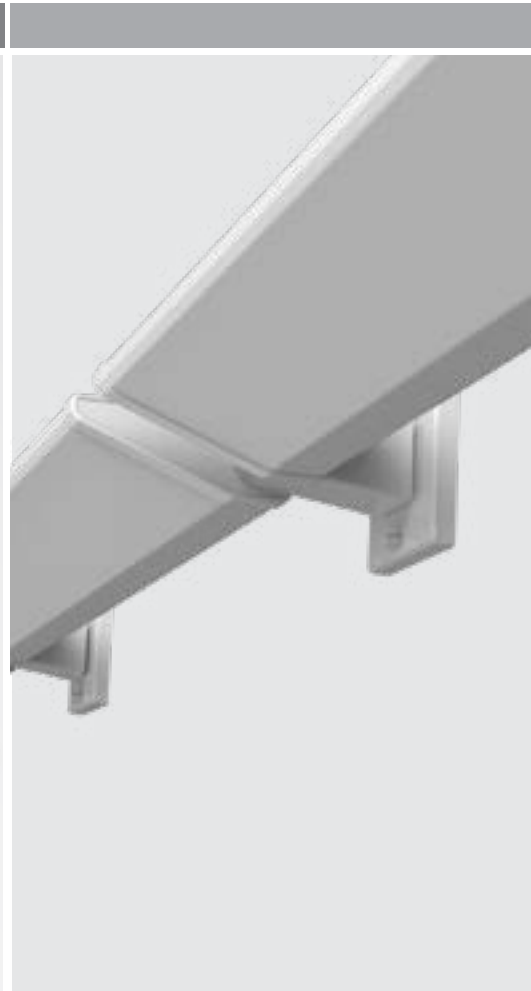

Show Off Your Space

Lighting can do more than take away darkness. The best lighting designs can also take your breath away — even while serving the practical purpose of bringing light to darkness.

Introducing Windirect LED, a re-invented family of high-performance asymmetric solutions from Winona. Updated and sleek forms offer unmatched versatility for indirect illumination, with advantages like improved life, efficacy, color consistency, controllability, and dimming.

The Windirect LED series presents upgraded alternatives to conventional light sources - from linear fluorescent to high wattage metal halide - allowing you to design lighting that is more creative and comfortable, while staying within your energy budget. Revel in glare-free indirect illumination or spectacularly highlight architectural features.

Various lumen packages and fixture sizes are included to suit a broad range of applications. Four design profiles combine with multiple mounting orientations to offer a multitude of options for indirectly lighting interior, natatorium, or exterior applications.

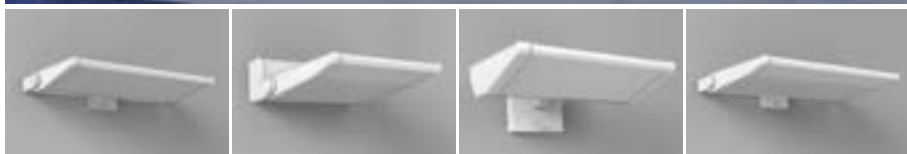

What is Superior Performance?

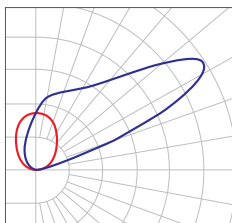

- True shallow angle asymmetric throw
- Smooth, striation-free uniform distribution
- Multiple profile sizes offer more design flexibility
- High output rivaling T5 fluorescent to 350w metal halide sources
- Superior efficacies of up to 112 lumens per watt

The Windirect Asymmetric LED family of products was purposely created as a design tool for the discriminating lighting designer, architect, and engineer. And we delivered on this intent with stringent criteria for beam control, distribution shape, forward throw, and efficacy. With four fixture profiles optimized for the LED source, this highly configurable family replaces conventional lamping from T5 fluorescent to 350 watt metal halide, saves energy, and produces a better quality of light.



No Compromise Lighting

The series of Windirect LED fixtures leverages the inherent strength of LED as a directional source by employing a completely new optical approach. The result is an efficient concentration of light energy with efficacy improvements so dramatic they meet Design Lights Consortium (DLC) requirements. Forget about compromising design versatility because of energy concerns.

But efficacy is only part of the performance story. Windirect LED optics incorporate shallow beam angle, peak candela, and uniform distribution — all features that are critical to the presentation of architectural grade asymmetric lighting. The result is pinpoint accuracy with exceptionally uniform, striation-free and scallop-free illumination on either horizontal or vertical planes. Superior performance enables tighter setbacks and wider spacing, translating to fewer luminaires as compared with typical asymmetric lighting products — saving even more energy, as well as initial purchase costs.



Intelligent Controls

The nLight® module option provides for easy "plug-and-play" networking with nLight control systems. The constant lumen management (N80) option extends LED longevity and saves an additional 10% in energy use over luminaire lifetime.

eldoLED®

Driver Solutions for LED Lighting

Smooth, flicker-free dim to dark (0.1%) by eldoLED® sets a new standard in architectural dimming.

Versatility to Fit Every Job

Four profile designs give you the flexibility to choose the size and shape that fits best into your space. The smallest, 801 profile, is available as an individual luminaire or a continuous linear system, in either normal or high output.

The 802 profile offers higher lumen output in only a slightly larger size. Individual 12 and 24-inch long luminaires deliver outputs that rival 39 and 70 watt metal halide. The 802 can also be specified as a linear system with all sizes available as surface-mount for wall, ceiling, cantilever, and pendant applications.

For even more intense illumination, choose the 803 and 804 profiles. The 803 series output is equivalent to 100 and 200 watt metal halide — at about 40% lower wattage — and is available in 12 or 24-inch lengths.

The 804 profile offers lumen packages equivalent to larger 150, 250, and 350 watt metal halide lamps but without all the drawbacks of the traditional source. Impressive lumen output with color consistency, long life, dimmability, and control — superior performance at lower operating costs!

Additionally, configurations of the Windirect LED Series are available to ship in 5 days or less with our Design2Ship™ Quick Ship program. This means meeting tight deadlines on the jobsite without sacrificing design or quality performance.



801 & 801L

- Individual or linear
- Normal or high output
- Up to 8' long



802 & 802L

- Individual or linear
- 3300 lumens per foot
- Up to 4' long



803

- Up to 10,000 lumens



804

- Up to 19,000 lumens



windirect™ LED

801

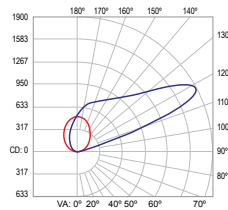

801

801L

Output	Energy	Length	Efficacy	Equivalent*
2236 lumens	20 watts	12"	112 LPW	39w Metal Halide
4472 lumens	40 watts	24"		70w Metal Halide
Normal: 559 lumens/ft	5.9 watts/ft	24"	112 LPW	T8 Fluorescent
HO: 1118 lumens/ft	11.7 watts/ft	36"		T5HO Fluorescent
		48"		
		96"		

802

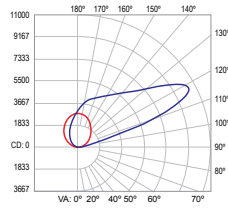

802

802L

Output	Energy	Length	Efficacy	Equivalent
3278 lumens	30 watts	12"	108 LPW	70w Metal Halide
6556 lumens	60 watts	24"		150w Metal Halide
3278 lumens/ft	30 watts/ft	24"	108 LPW	2-Lamp T5HO Fluorescent
		36"		
		48"		

803

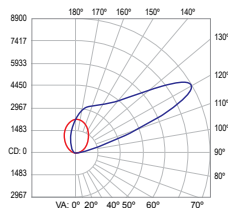

803

Output	Energy	Length	Efficacy	Equivalent
4988 lumens	46 watts	15"	107 LPW	100w Metal Halide
9976 lumens	93 watts	24"		175w Metal Halide

804

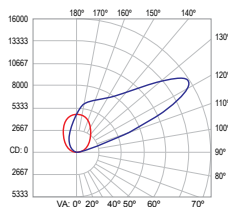

804

Output	Energy	Length	Efficacy	Equivalent
6571 lumens	61 watts	12"	108 LPW	150w Metal Halide
13142 lumens	121 watts	24"		315w Metal Halide
19713 lumens	182 watts	36"		350w Metal Halide

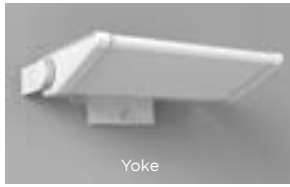

Yoke

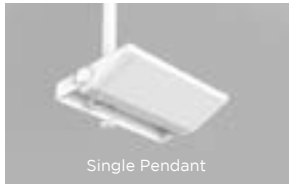

Single Pendant

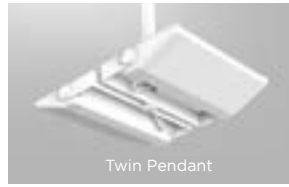

Twin Pendant

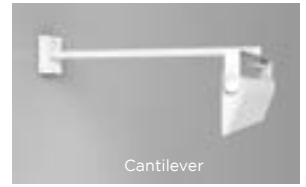

Cantilever



Continuous Surface Wall Hub

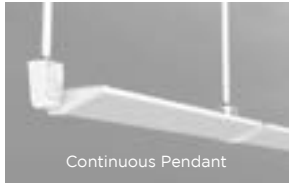

Continuous Pendant



Continuous Cantilever



Continuous Base

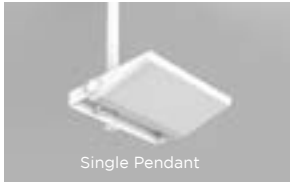

Single Pendant

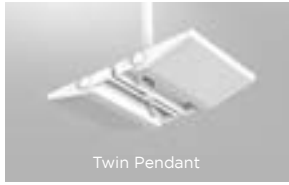

Twin Pendant

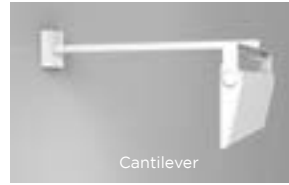

Cantilever



Continuous Base



Continuous Surface Wall

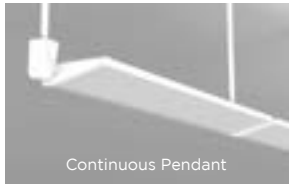

Continuous Pendant



Continuous Cantilever

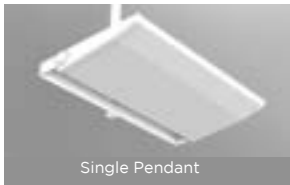

Single Pendant



Twin Pendant

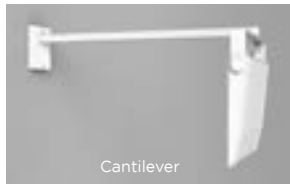

Cantilever

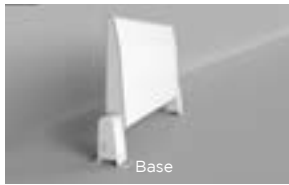

Base



Single Pendant

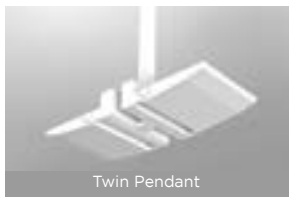

Twin Pendant



windirect[®]
LED ASYMMETRIC LIGHTING

WINONA[®]
solutions | forms | light

Complete warranty terms located at: <http://www.acuitybrands.com/resources/terms-and-conditions>